



Instruction manual

# TESA-hite 400 / 700





<b>LIST OF CONTENTS</b>		<b>PAGE</b>
<b>1</b>	<b>Main features</b>	<b>4</b>
<b>2</b>	<b>Installation</b>	<b>5</b>
2.1	Unpacking and setting up	5
2.2	Starting the instrument	6
2.3	Short instructions for use	7
<b>3</b>	<b>Description of the components</b>	<b>10</b>
3.1	Instrument base	10
3.2	Air-cushion base	10
3.3	Vertical column, measuring head and movement of the head	10
3.4	Power supply	11
3.5	Measuring system	11
3.6	Automatic measuring value correction	11
<b>4</b>	<b>Measuring</b>	<b>12</b>
4.1	Basic principles	12
4.2	Display and function keys	12
4.2.1	Definition of display symbols	13
4.3	Program functions	14
4.4	Probing procedure at the contact point	16
4.5	Establishing the probe constant for length measurements with inversion of the probing direction	17
4.6	Measuring features with flat surfaces	18
4.7	Measuring features with cylindrical surfaces	18
4.8	MODE 1, Measuring lengths in one direction, without probe constant	19
4.9	MODE 2, Measuring lengths in two directions, with probe constant	20
4.10	Procedure for detecting the culmination point	21
4.11	MODE 3, continuous display	27
4.12	PRESET function	29
4.13	Measuring parallelism deviations	33
4.14	Measuring perpendicularity deviations	36
4.15	Use of the fine adjustment	39
<b>5</b>	<b>Instrument configuration</b>	<b>39</b>
<b>6</b>	<b>Error messages</b>	<b>44</b>
<b>7</b>	<b>Maintenance</b>	<b>44</b>
7.1	Cleaning	44
7.2	Charging the battery	45
<b>8</b>	<b>Delivery programme</b>	<b>45</b>
8.1	Optional accessories	46
<b>9</b>	<b>Technical data</b>	<b>49</b>
9.1	Description of the RS 232 interface	50
9.1.1	Monodirectional data transmission	50
9.1.2	Bidirectional data transmission	50
<b>10</b>	<b>Warranty</b>	<b>50</b>
<b>11</b>	<b>Declaration of conformity</b>	<b>51</b>

1 MAIN FEATURES

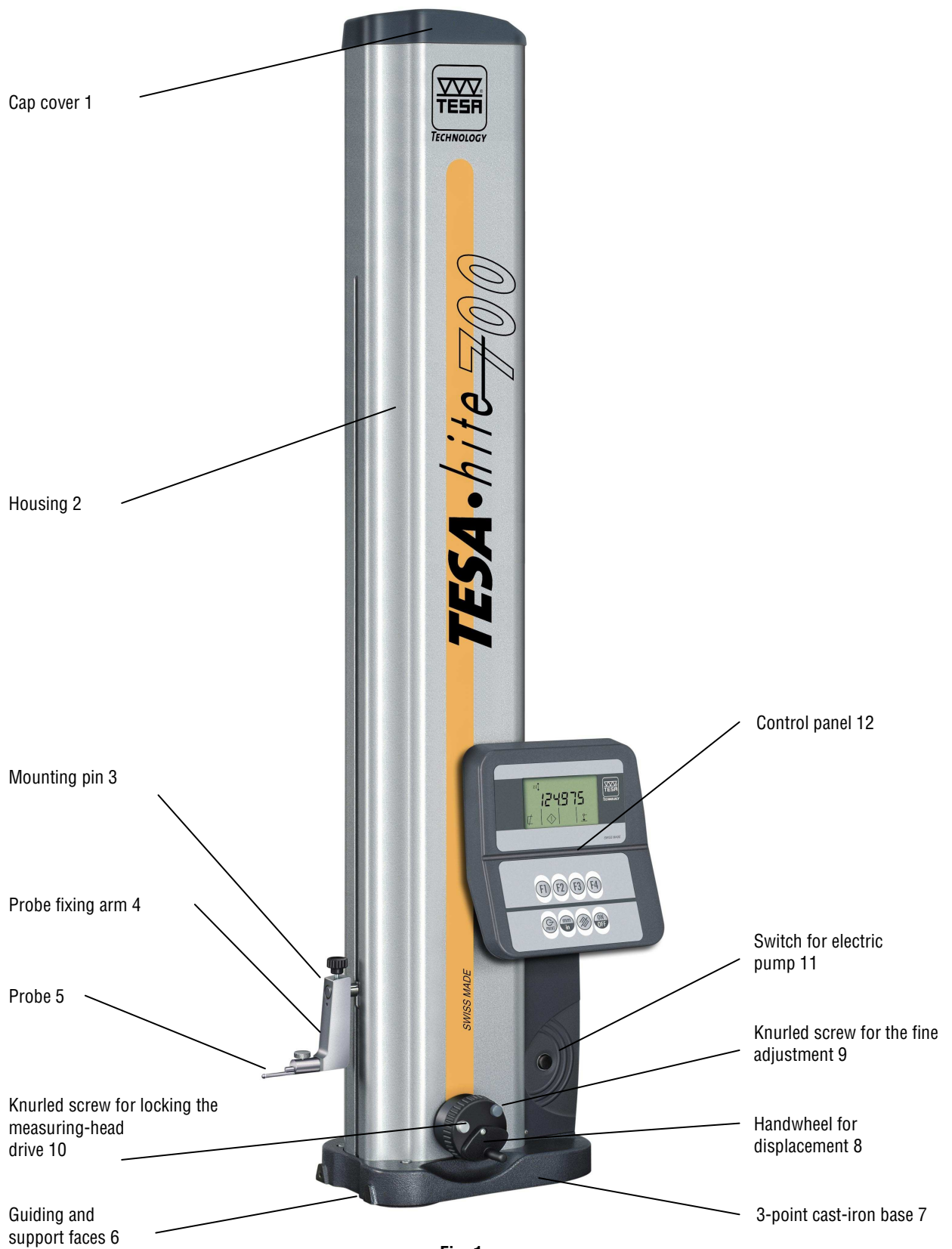

Fig. 1

## 1 MAIN FEATURES

The TESA-Hite 400 / 700 is a mains-independent height gauge, which is suitable for measuring lengths in the form of external, internal, step, height, depth and distance dimensions. A cast-iron base with 3 integrated finish-ground supporting lugs ensures the stability of the TESA-Hite 400 700. By activating the integrated electric pump, an air cushion can be created to facilitate the movement of the instrument. A rigid column is located under the protective cover, equipped with a guide system that is absolutely straight and perpendicular to the base. On this slides the measuring head and the movement of the head is measured by an opto-electronic measuring system (TESA patent). The measured readings are obtained in a very simple and reliable manner. Firstly the probe is brought into contact with the point to be measured then immobilised to permit it to stabilise; then, by performing a further slight rotation of the drive system, the measured reading is automatically recorded by a dynamic process, with the measuring force at all times remaining constant. An acoustic signal confirms that the reading has been recorded and it is immediately displayed and, if required, transmitted via the RS 232 output. Cylindrical surfaces (bores and shafts) can also be measured simply and reliably by automatically probing to find the culminating point. Although the TESA-Hite 400 / 700 is manufactured to the highest precision, automatic microprocessor assisted correction makes it even more accurate: Correction values memorised in the instrument compensate for systematic errors when measuring lengths.

## 2 INSTALLATION

### 2.1 Unpacking and setting up

The TESA-Hite 400/700 is delivered ex factory, packed to protect it from impact and corrosion. Please use the original packing materials for any subsequent transport.

#### IMPORTANT:

Your instrument is supplied with a 6V rechargeable battery already inserted. For recharging the battery, see section 7.2.

Before fitting the standard accessories, release the measuring carriage by unscrewing the light grey knurled screw (10) Fig. 1 on the hand wheel.

Securely fit the probe 5 to the probe-fixing arm 4 itself fitted to the mounting pin 3. Ensure that the two knurled screws on the probe-fixing arm are well tightened.

After, unlock the measuring head by moving the slide downward until the insert touches the granite plate; exert a force on the handwheel, like if you would do a probing down; this will unlock the transport carriage from the measuring carriage.

However, we recommend you firstly read this instruction manual.

## 2.2 Starting the instrument

After the instrument is turned on (ON/OFF), a double bar appears on the screen (Fig.2.1)

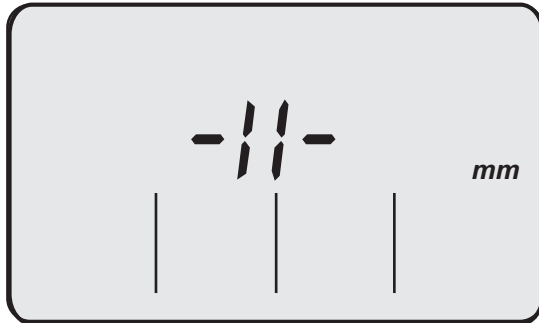

Fig.2.1

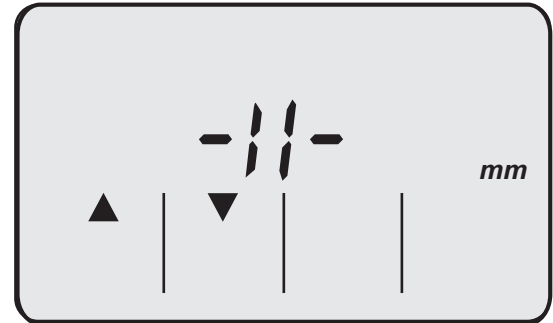
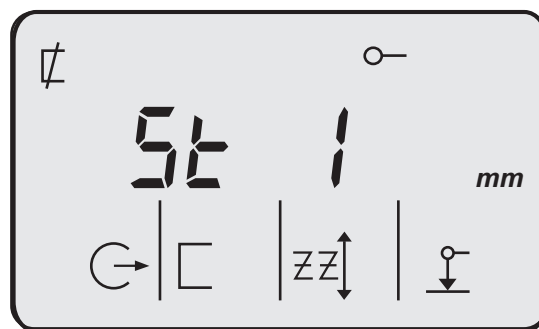

Fig.2.2

To enter in the measuring mode, move slowly the measuring head at a certain distance until the 2 triangles appear (Fig.2.2); then the movement can be done faster until the reference mark has been crossed.

After having crossed the reference, the TESA-Hite 400 / 700 is in the measuring mode and the following display appears:



- F1 Switch-on auto Print mode
- F2 Establish the probe constant
- F3 Enter in ZZ mode
- F4 Introduction of a PRESET

For more detailed information on the probing procedure for taking readings, please consult the chapter 4.

### Remark:

By turned on, if first the F1, then the F1 and ON/OFF keys are simultaneously activated; after deactivate the ON/OFF and then the F1 keys; the instrument will go in the configurations menu. For further information about it, please consult the chapter 5.

### 2.3 Short instructions for use

#### Display and keys

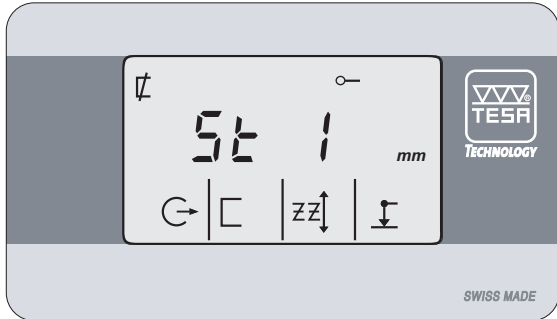

- ← Active functions
- ← Main display
- ← Functions available through keys F1 to F4

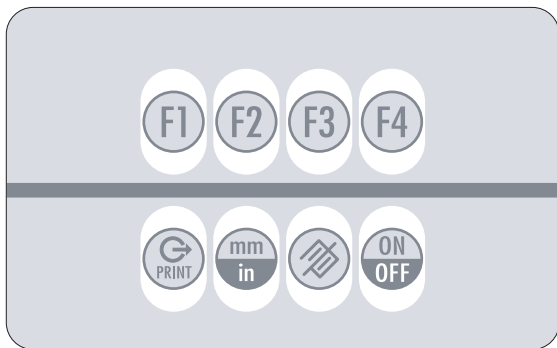

- ← Function keys F1 to F4

- ↑ Transmit a reading to a peripheral
- ↑ Change unit
- ↑ Cancel last function or last probing
- ↑ Switching ON / OFF



#### MODE 1

#### Measuring length in one direction, without calibration

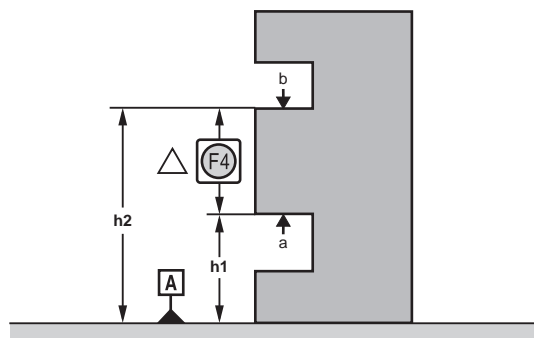

**MODE 2 Measuring length in two directions, with calibration**

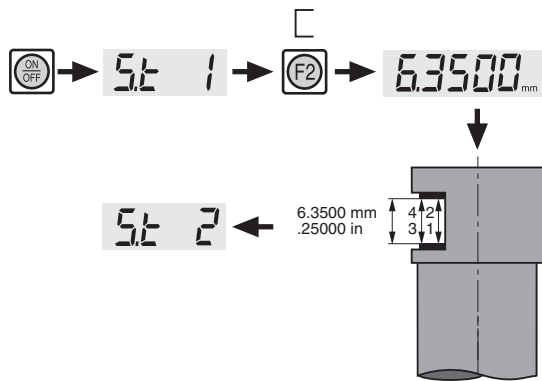

With reading Scatter		Display resolution
5 ÷ 10 μm		0.01 mm
.0002 ÷ .0004 in		.0005 in
10 ÷ 50 μm		0.1 mm
.0004 ÷ .002 in		.005 in
50 μm		1 mm
.002 in		.05 in

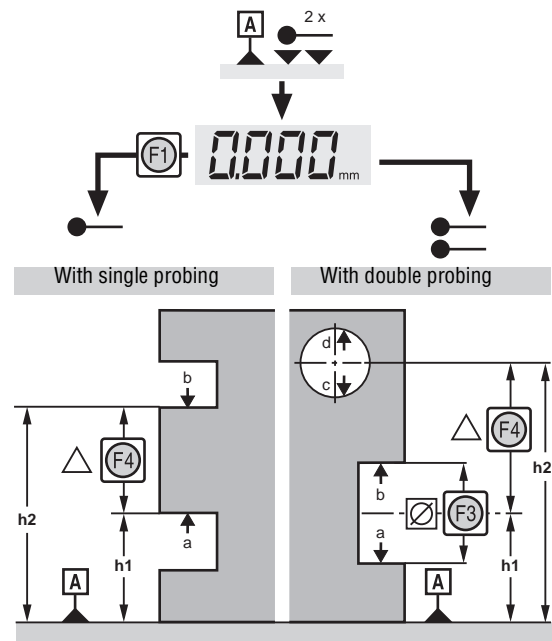

**Procedure for detecting the culmination point**

Probe normally without releasing the probe; wait about 1 second in the probing zone. The system will automatically switch to culmination-point detection mode. Move either the part or the TESA-Hite 400/ 700 by means of its air cushion so that measuring probe passes through the culmination point. The TESA-Hite 400 / 700 has a system for automatically detecting the shape of the surface being probed (concave or convex). Hence it is not necessary to indicate to the TESA-Hite 400 / 700 whether it is probing a bore or a shaft as this will be detected automatically according to the upward or downward probing of the maximum or minimum culmination point. Once the symbol ▲ or ▼ appears on the display, the system will have automatically detected the maximum or minimum point of the bore or shaft to be measured. The measuring head can now be withdrawn.





**MODE 3      Continuous display**



**« PRESET » function (mode 1, 2 and 3)**

(F4)

0.000 mm

▲ | ▼ | ◀ | ⇨

(F1) (F2) (F3) (F4)

▲ Choice: 1 → 2 → 9 → . → 0

▼ Choice: 0 → . → 9 → 2 → 1

◀ Shift one position to the left

⇨ Confirm preselected reading

Cancel preselected reading

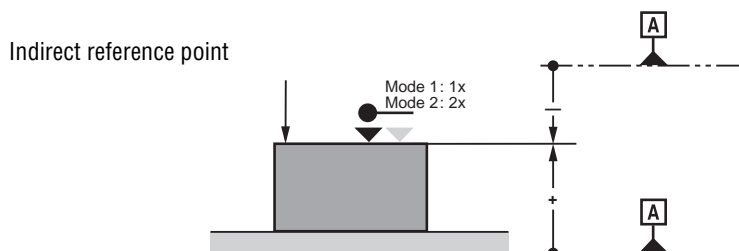

### 3 DESCRIPTION OF THE COMPONENTS

#### 3.1 Instrument base

The base is chemically nickel-plated in order to make it very resistant to corrosion. Its lower face, which has been machined to ensure that it is rigorously flat, incorporates three finely-machined support lugs that guarantee the stability of the TESA-Hite 400 / 700. These lugs form a large surface so that any grooves or other similar irregularities in the surface plate can be comfortably cleared. The lugs 6 (Fig. 1) are designed especially for supporting the TESA-Hite 400 / 700 against a parallel rule or for guiding it along such a rule, for example.

#### 3.2 Air-cushion base

The air-cushion base, which is generated by the pneumatic system linked to the electric pump integrated into the instrument, permits the height gauge to be moved safely and easily. Once activated, manually with the button 11 (Fig. 1), the pump creates an air-cushion only a few  $\mu\text{m}$  thick between the height gauge base and the surface plate so that TESA-Hite 400 / 700 can be displaced effortlessly and quite wear-free. The thickness of the air cushion can be set according to the surface quality of the granite plate. This is done by turning screw (Fig. 3), which acts on the valve located into the pneumatic system. Experience has shown that the air cushion should not be thicker than necessary. Once enabled, it has to support the weight of the height gauge while contacting the surface plate lightly.



Fig. 3

#### 3.3 Vertical column, measuring head and movement of the head

The rigid vertical column is perpendicular to the base, to which it is permanently fixed. A measuring head slides on the guide and the movement of the head is recorded by an opto-electronic measuring system (TESA patent). The measuring head can be moved in infinitesimal increments by the fine-adjustment system, for example when using fine probes or measuring small bores. The knurled screw 9 (Fig. 1) is used to lock the measuring-head movement that is thus left free for scanning. However, if necessary, the head itself can also be locked by using the built-in system. To do it, block the handwheel by using the screw 8 (Fig. 1) and move the probe upwards to the stop.

### 3.4 Power supply

The TESA-Hite 400 / 700 is powered by a 6V rechargeable battery (N° 00760157). This is recharged using the mains adapter N° 04761054 and the cable EU N° 04761055 or US N° 04761056 (see chapter 7.2 – Charging the battery).

### 3.5 Measuring system

The TESA-Hite 400 / 700 incorporates an opto-electronic measuring system which digitally records the measured dimension, called the mesurande (TESA patent). A glass scale marked off in incremental divisions serves as a material measure. According to the reflection principle, the glass scale is scanned contactlessly by a sensor with photo-sensitive elements. After analogue/digital conversion, the measurement signal is transmitted for processing. From point A, the reading system can be moved downwards to the respective trigger points. Once one of these points has been reached, the reading of the value is triggered, that is to say that the position of the measuring head in relation to the incremental divisions is read off by the sensor. The distance C, symmetrical in relation to the position of each trigger point in the travel of the measuring system is kept for seeking the culminating point when probing cylindrical surfaces. (Read section 4.7 also).

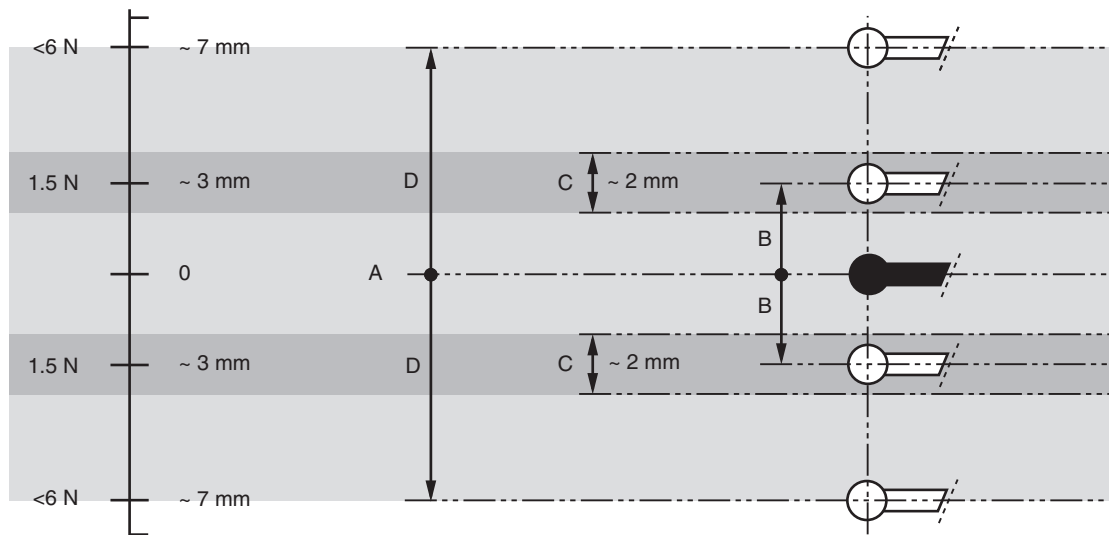

- A** Starting position
- B** Travel to upper or lower trigger point for taking reading
- C** Partial measuring span for finding the culmination point
- D** Travel in one direction from the neutral position to the spring-loaded end stop

### 3.6 Automatic measuring value correction

It is agreed that a perfectly accurate measuring instrument is impossible to produce. Therefore, the value indicated by any instrument comprises a deviation from the true value; this deviation is composed of the bias errors and the random errors. Random errors cannot be predicted since they are the result of influences that cannot be controlled, e.g. the value dispersion. Bias errors, on the other hand, as for example the deviations of the scale divisions on the material measure or the form and positional errors of the measuring head guides can be corrected once they have been measured. To correct length measurements, after the TESA-Hite 400 / 700 has been completely assembled; the actual errors are determined step-by-step by means of a system of stepped gauge blocks.

The correction values thus calculated will subsequently be memorised in the electronic module of the instrument. Thus, every measurement read off by the TESA-Hite 400 / 700 will be automatically corrected before being displayed.

## 4 MEASURING

### 4.1 Basic principles

To measure with the TESA-Hite 400 / 700 necessarily means that the way the measured values are determined depends to a large extent on the kind of measurement tasks the user has to carry out. Special attention should be paid to the main following points:

- Determining the reading by one or two probe contacts
- Measuring with or without change of probe direction
- Measuring with or without seeking the culmination point.

### 4.2 Display and function keys

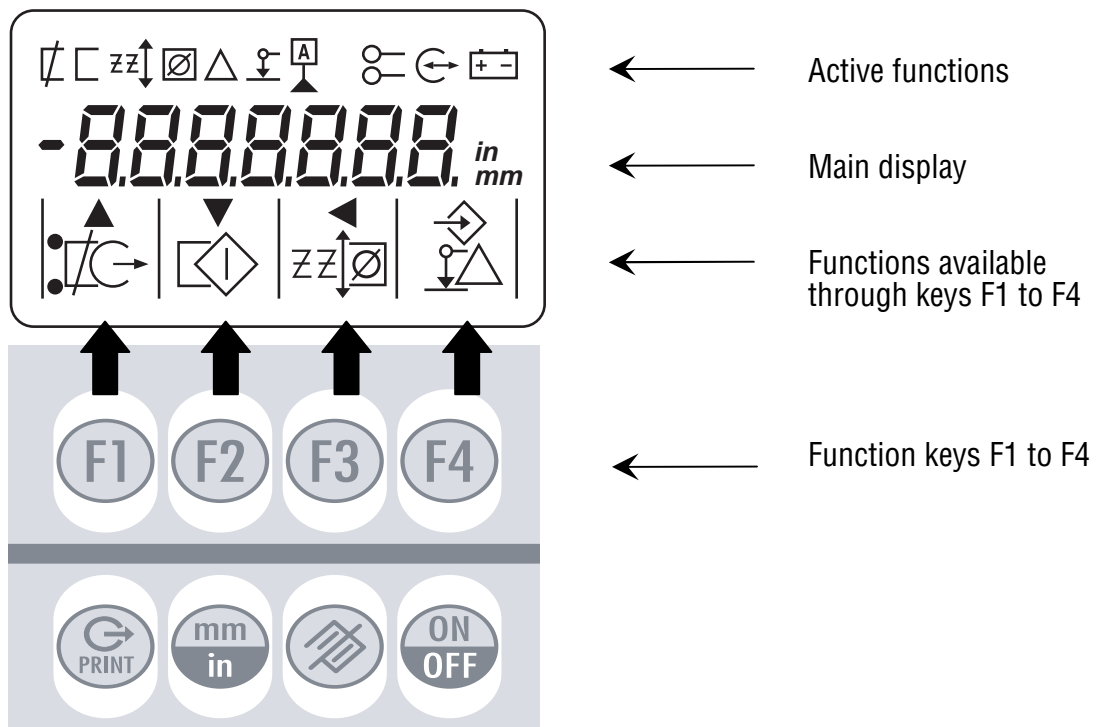

Transfer a reading to a peripheral



Cancel last function or probing

















Change unit



Switching ON / OFF

### 4.2.1 Definition of display symbols

- 1  Length measurements in one direction, without probe constant (Measuring mode 1)
- 2  Length measurements in two directions, with probe constant (Measuring mode 2)
- 3  Continuous display (Measuring mode 3)
- 4  Display of the difference between the last two probe contacts (Measuring mode 2)
- 5  Display of the difference between the last two displayed readings (Measuring modes 1 and 2)
- 6  Measurements with 2 probe contacts per length measurement (Measuring mode 2)
- 7  Measurements with 1 probe contact per length measurement (Measuring mode 2)
- 8  Establishing a new reference (Measuring modes 1, 2 and 3)
- 9  «PRESET» function (presetting of numerical values) (Measuring modes 1, 2 and 3)
- 10  Automatic data transfer to a peripheral
- 11  Confirmation and further registering of data in the instrument memory
- 12  Increment digit, in measuring mode this indicates the detection of the maximum culmination point
- 13  Increment digit, in measuring mode this indicates the detection of the minimum culmination point
- 14  Shifting a digit to the left
- 15  Start the measurement of the parallelism deviation

### 4.3 Program functions

<b>MEASUREMENT TASKS</b>				
Length dimensions			Form dimensions	
Step dimensions Height dimensions Depth dimensions	External dimensions: - Rib width - Shaft diameter (culmination)  Internal dimensions: - Groove width - Bore diameter (culmination)  Centre distances: - Ribs, shafts, grooves, bores	Determining distances during a continuous measurement process	Parallelism deviations	Perpendicularity deviations  Run-out deviations
Measurements without change of probe direction	Measurements with change of probe direction	« Continuous » display with the program functions excluded	Measuring the MAX – MIN deviation	Measuring with a digital instrument connected to the RS port, using the interface N° 04760070 or with a TESATAST
Without taking the probe constant	With taking the probe constant			
Measuring mode 1	Measuring mode 2	Measuring mode 3		

**Measuring mode 1**

Length measurements in one direction without probe constant



**Measuring mode 2**

Length measurements in two directions with probe constant



**Measuring mode 3**

Continuous display



**Turn instrument On**

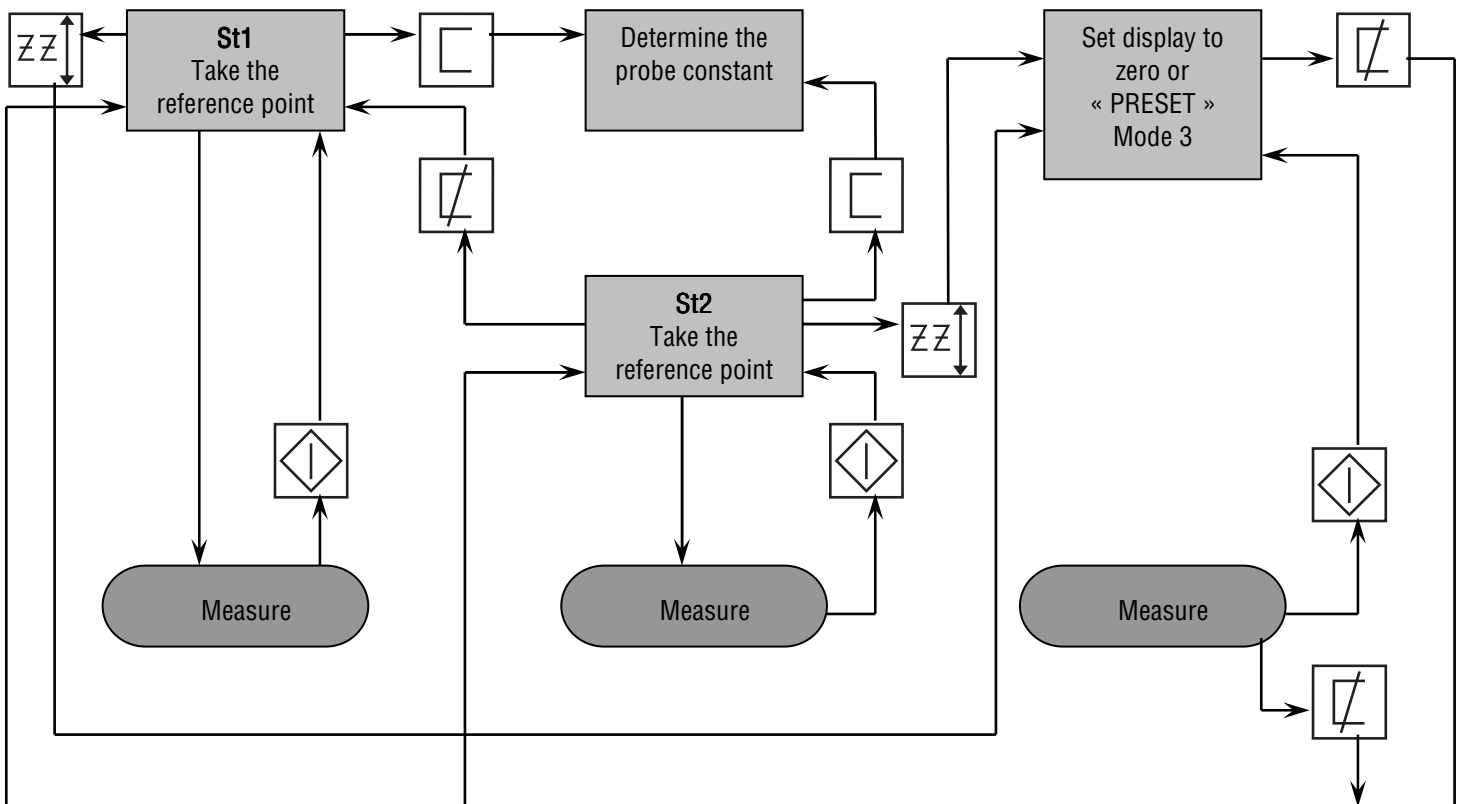

#### 4.4 Probing procedure at the contact point

In order to ensure the reliability of the measured values, the following condition must be fulfilled: the probe 5 should be firmly attached to the probe fixing arm 4 which in turn is fixed to the mounting pin 3. Make sure that both knurled screws on the fixing arm are tightened.

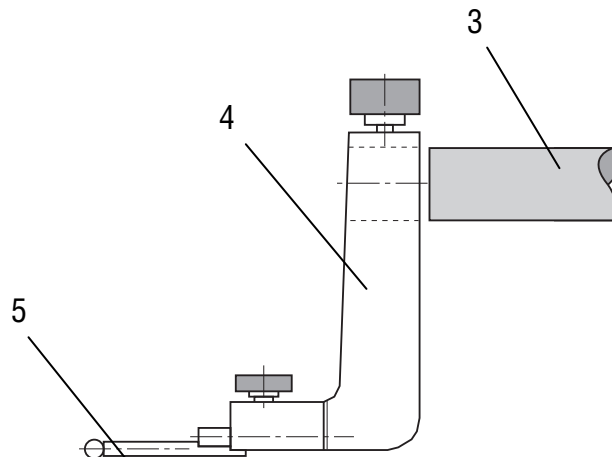

#### Probe contact procedure for the reading the measured values

- Use the handwheel 8 (Fig. 1) to rapidly move the measuring head.
- Use the knurled ring to bring the probe into contact with the measuring point on the work piece, but not right up to the switch point.
- Pause for a second or so.
- Approach the measuring head by continuing to turn the knurled ring slowly until an acoustic signal confirms the taking of the reading.
- Withdraw the probe from the surface of the work piece.

For optimum results when taking the readings, the measuring point should always be probed with the same careful regular movement. When the speed with which the measuring head approaches the work piece is reduced to an absolute minimum at the end of its travel, the probe will make precise and bounce-free contact. The readings thus obtained will be reliable and highly repeatable.



#### 4.5 Establishing the probe constant for length measurements with inversion of the probing direction

When bores, shafts, grooves, etc. are measured with a change of probe direction, a gauge-head constant must be taken into account. In order that the user may effect all these measurements without having to resort to tire some calculations, the gauge-head constant is determined on a suitable master gauge whose actual dimension is known. Setting piece No. 00760219 is provided with the instrument. By combining the three gauge blocks of which it consists, it has a total internal or external dimension of 6,350 mm / .25000 in.

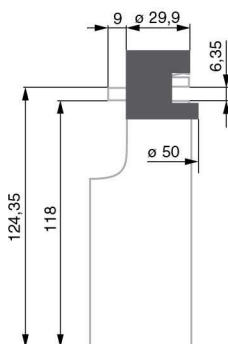

#### Remark

- Use only the setting piece supplied with the TESA-Hite 400 / 700 bearing with the N° 00760219 and the same production number as the instrument.
- The final TESA-Hite 400 / 700 verification and the certificate supplied both refer to this reference gauge.

The gauge-head constant, which is a permanent correction factor, is calculated by the built-in program once the measurements on the master-gauge have been completed; it is then recorded and automatically taken into account for all subsequent measurements.

By applying a gauge-head constant, the following features – which can affect the measurements – will be considered or compensated:

- Diameter of the probe ball or disc used.
- Elastic distortion of the probe and its support under the action of the measuring force.
- Hysteresis errors of the measuring system.

The gauge-head constant must be redetermined after any change in the measuring conditions. Main causes of change:

- Turning the instrument off.
- Changing the probe.
- Changing the probe position.

The «Determination a gauge-head constant» function requires at least two probe contacts at each measuring point. The difference between the two readings at each measuring point should not exceed 1  $\mu\text{m}$ . Should the instrument indicate a greater difference, it will be displayed and the operator must either accept that difference or repeat the gauge-head constant determination operation.

#### 4.6 Measuring features with flat surfaces

The probes used for contacting flat surfaces are those producing point contact. Such probes are either ball, barrel or disk shaped (see standard and optional accessories).

In measuring mode 1, the measurements are taken exclusively by probing. All measurements must be taken in the same direction.

In measuring mode 2, the measurements can involve one or two contacts and can be recorded with or without inverting the probe direction.

#### 4.7 Measuring features with cylindrical surfaces

Probes appropriate for contacting cylindrical surfaces are identical to those used for flat surfaces. If the diameter of bores or shafts has to be determined in addition to their height, the two contacts have to be made at the diametrically opposed culmination points.

To determine the culminating point, proceed as follows:

- Use the handwheel 8 to rapidly move the measuring head and the probe
- Use the knurled ring to bring the probe into contact – slightly off centre – with the bore or shaft to be measured, but not right up to the switch point.
- Pause for a second or so.
- Move the measuring head forward by continuing to turn the knurled ring slowly until an acoustic signal confirms the taking of the reading.
- After about 1 second, the probing force will be displayed graphically on the control-panel display.
- Keep the probing force within the limits and manually move the part or the TESA-Hite 400 / 700 so that the probe passes through the culmination point. Once the symbol ▲ or ▼ appears on the display, the system will have automatically detected the maximum or minimum point of the bore or shaft to be measured.
- The measuring head can now be withdrawn.
- Repeat the operation in the other direction to determine the diameter.

### 4.8 MODE 1 Measuring lengths in one direction, without probe constant

Measuring without inversion of gauge-head direction (Mode St 1)

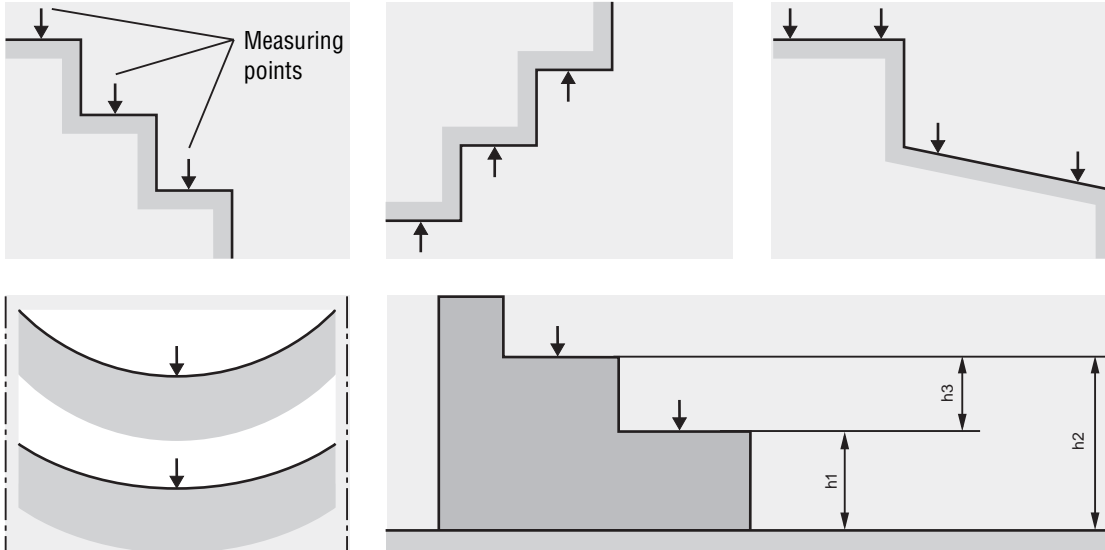

#### Important

To ensure optimum instrument measuring accuracy, the standard probe-fixing arm (N° 00760143) must be aligned on the working surface with the air cushion deactivated. The accessory N° 00760225 can be used to do this alignment.



Automatic Print  
Available after switch-on



Two possibilities for cancelling the automatic point:

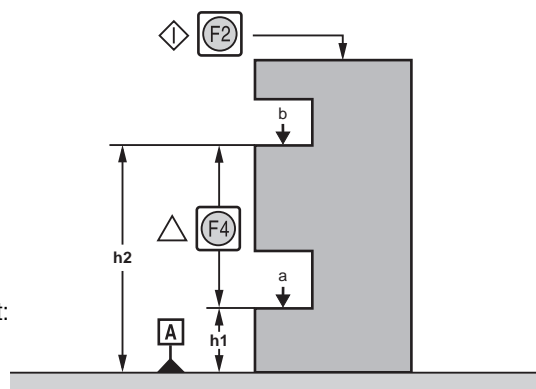

### 4.9 MODE 2 Measuring lengths in two directions, with probe constant

Measuring with inversion of gauge-head direction (Mode St 2)

#### FLAT SURFACES

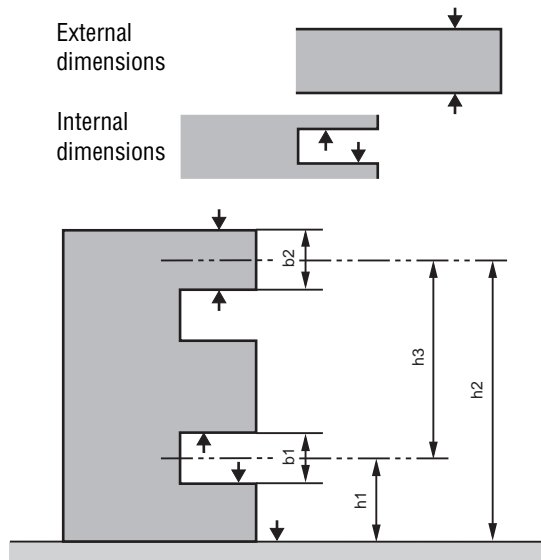

#### CYLINDRICAL SURFACES

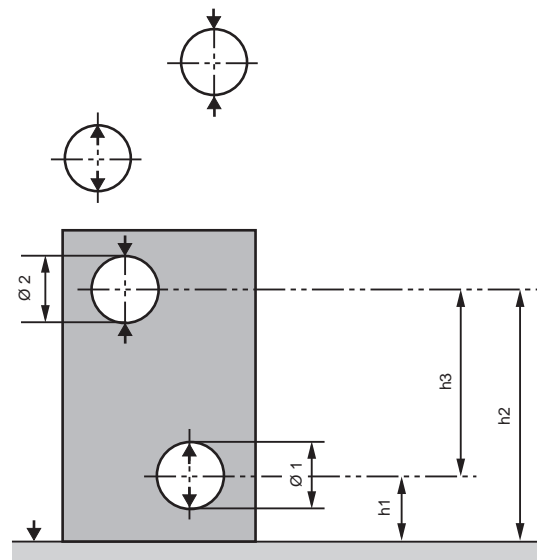

#### Important

To ensure optimum instrument measuring accuracy, the standard probe-fixing arm (N° 00760143) must be aligned on the working surface with the air cushion deactivated. The accessory N° 00760225 can be used to do this alignment.

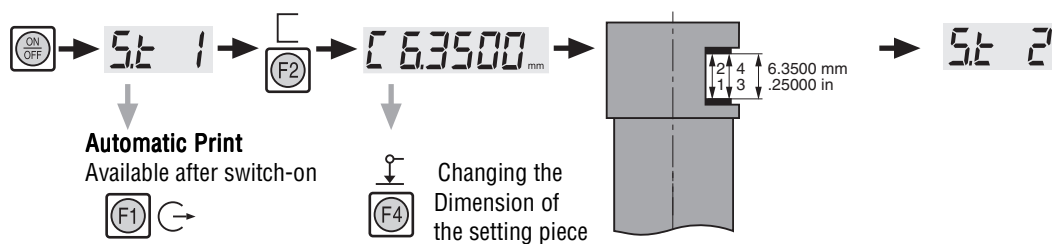

If the reading dispersion is too great, the display indicates:



**F2** Deviation not accepted, recalibrate

**F4** Accept with resolution adapted as follows:

5 ÷ 10µm	0.01 mm
.0002 ÷ .0005 in	.0005 in
10 ÷ 50µm	0.1 mm
.0005 ÷ .002 in	.005 in
> 50µm	1 mm
> .002 in	.05 in

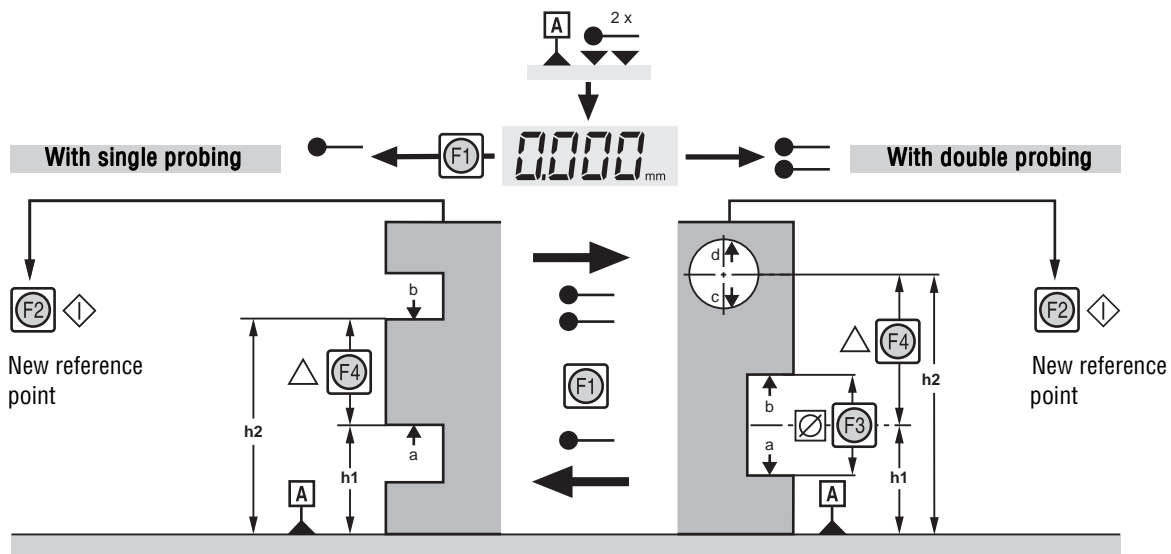

#### 4.10 Procedure for detecting the culmination point

The TESA-Hite 400 / 700 has an automatic system for determining the shape of the surface being probed (concave or convex). Hence, it is not necessary to indicate to the TESA-Hite 400 / 700, whether the surface being probed is flat, a bore or a shaft, as it can independently detect whether there is a culminating point and, according to whether it is an upward or a downward probe, whether it is a maximum or a minimum. In short, just probe normally and release the key if the surface is flat or wait about 1 second in the probing zone to see whether the probe is in contact with a bore or a shaft and whether the diameter is to be measured. The system automatically switches to culminating-point detection mode. Then just move the part or the TESA-Hite 400 / 700 so that the probe passes through the culmination point.

Once the symbol ▲ or ▼ appears on the display, the system will have automatically detected the maximum or minimum point of the bore or shaft to be measured. At this point, the measuring key can be released.

**MEASURING**

Without searching for the culmination point

With searching for the culmination point

Plane parallel surfaces

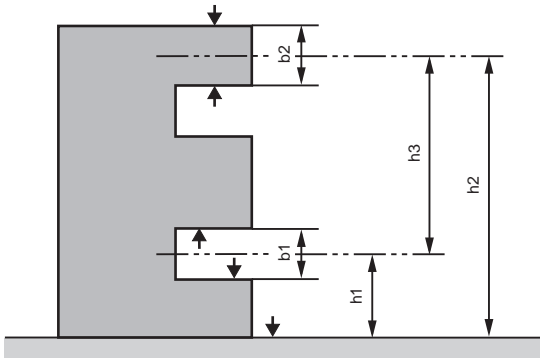

Search for culmination point unnecessary

Cylindrical surfaces

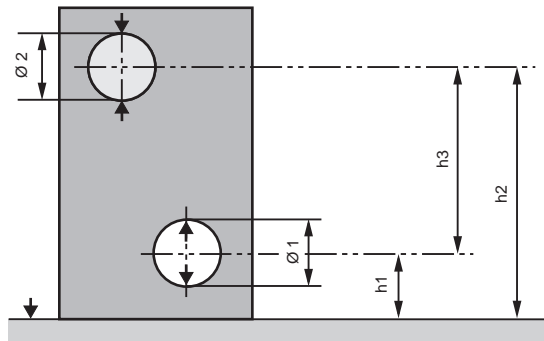
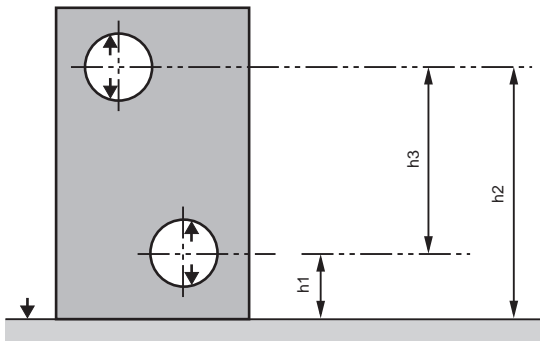

Without determining Ø

With determining Ø

**REMARK:**  
Not convenient for external dimensions

With manual probing movements to find culmination points

Automatic triggering of memorising

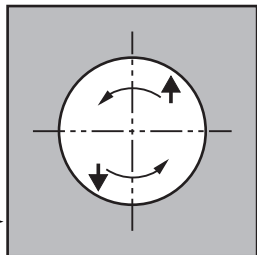

Detailed procedure for detecting the culmination point

Probe/Contact	Display	Active keys	Comments
		mm /in (F1) (F2) (F3) (F4)	Recording constant OK. Probe reference
			Reference OK.
			Probe diameter Internal, downward. Normal probing
		<ul style="list-style-type: none"> <li>Place the gauge head slightly off-centre with respect to the bore axis.</li> <li>After waiting about 1 second in the probing zone.</li> <li>Culmination proposal: if passing through the neutral point without culmination=normal probing.</li> <li>Adjust the force in upper zone</li> </ul>	
			Move the part or the TESA-Hite 400/700 so that the gauge head passes through the maximum or the minimum point. <b>Culmination point detected.</b> The bar graph indicates the current measuring force.

Detailed procedure for detecting the culmination point

Probe/Contact	Display	Active keys	Comments
			<p><b>Culmination point overshoot.</b></p>
			<p>To improve accuracy, it is possible to make several passes through the culmination point. Only the highest or Lowest point will be memorised.</p>
			<p><b>Gauge head released.</b> First point memorised. Await next action.</p>
		<p><b>F1</b></p>	<p><b>Aborts culmination.</b> Return to last measurement displayed.</p> <ul style="list-style-type: none"> <li>Place the gauge head slightly off-Centre with respect to the bore axis.</li> <li>Wait about 1 second.</li> <li>Move the part or the TESA-Hite</li> </ul> <p><b>Second contact.</b> <b>Culmination point detected.</b> The bar graph indicates the current measuring force.</p>
		<p><b>F1</b> <b>F2</b> <b>F3</b> <b>F4</b></p>	<p><b>End of bore measurement.</b> Display centre of diameter</p>



Detailed procedure for detecting the culmination point

Probe/Contact	Display	Active keys	Comments
<p>F3</p> <p>Beep</p>		<p>F1 F2 F3 F4</p> <p>F3</p> <p>F4</p>	<p>Call up diameter display.</p> <p>Force diameter mode</p> <p>Cancel diameter mode</p>
<p>Beep</p>			<p>External diameter Probe, downward. Normal probing</p>
<p>Wait 1 second probing zone</p>		<p>▲</p> <ul style="list-style-type: none"> <li>Place the gauge head slightly off-Centre with respect to the shaft axis.</li> <li>Wait 1 second in probing zone.</li> <li>Adjust the force in the lower zone.</li> </ul>	<p><b>Culmination proposal.</b></p>
<p>Beep Beep</p>			<p>Move the part or the TESA-Hite 400/700 so that the gauge head passes through the maximum or the minimum point. <b>Point de rebroussement détecté.</b> The bar graph indicates the current measuring force.</p>
			<p><b>Gauge head released.</b> First point memorised. Await next action.</p> <p>Aborts culmination. Return to last measurement displayed.</p>

Detailed procedure for detecting the culmination point

Probe/Contact	Display	Active keys	Comments
		<p>⚠</p> <ul style="list-style-type: none"> <li>Place the gauge head slightly off-Centre with respect to the shaft axis.</li> <li>Wait about 1 second.</li> <li>Move the part or the TESA-Hite.</li> </ul> <p><b>Second contact.</b>  <b>Culmination point detected.</b>                      The bar graph indicates the current measuring force.</p>	
		<p>(F1) (F2) (F3) (F4)</p>	<p><b>End of shaft measurement.</b>                      Display centre of diameter.</p>
<p>(F3)</p>		<p>(F1) (F2) (F3) (F4)</p> <p>(F3)</p> <p>(F4)</p>	<p><b>Call up diameter display.</b></p> <p>Force diameter mode</p> <p>Cancel diameter mode</p>
<p>(F3)</p>		<p>(F3)</p> <p>(F4)</p>	<p><b>Forced display of diameter</b></p> <p>Displays centre</p> <p>Quit diameter display priority.</p>
<p>Wait 1 second in probing zone</p>			<p><b>Measure depth of groove.</b></p> <p>Probing mode 1 (St1)</p>

Detailed procedure for detecting the culmination point

Probe/Contact	Display	Active keys	Comments
			<p><b>Contact force too weak:</b> culmination point not detected.</p>

4.11 MODE 3 Continuous display

Continuous display mode, as its name indicates, permits the TESA-Hite 400 700 to continuously display the height of the measuring probe. To do this, proceed as follows:

- Enter ZZ mode by pressing the F3 key
- Block the measuring head, please consult the chapter 4.14
- The counter can be reset at any time and at any height by means of the F2 key.

Detailed procedure of the continuous display mode

Probe/Contact	Display	Active keys	Comments
		<p>mm /in</p> <p>(F1)</p> <p>(F2)</p> <p>(F3)</p> <p>(F4)</p>	<p>Switch-on auto Print mode</p> <p>Establish the probe constant</p> <p>Enter in ZZ mode</p> <p>Introduction of a PRESET</p>
<p>(F3)</p>		<p>mm /in</p> <p>(F1)</p> <p>(F2)</p> <p>(F4)</p>	<p><b>ZZ mode</b> <b>Continuous display</b></p> <p>Return in St 1 mode</p> <p>Set the display to zero</p> <p>Introduction of a PRESET</p>

Detailed procedure of the continuous display mode

Probe/Contact	Display	Active keys	Comments
(F1)		mm /in (F1) (F2) (F3) (F4)	Switch-on auto Print mode Establish the probe constant Enter in ZZ mode Introduction of a PRESET

If you enter from St 2 into the ZZ mode, the probe constant will be memorised. By the exit of the ZZ mode the instrument will return in St 2.  
 Attention to take again the probe constant if you have moved or changed the gauge head.

		mm /in (F1) (F2) (F3) (F4)	Enter in St 1 mode Establish the probe constant Enter in ZZ mode Introduction of a PRESET
--	--	--	--

(F3)		mm /in (F1) (F2) (F4)	<b>ZZ mode                      Continuous display</b> Return in St 2 mode Set the display to zero Introduction of a PRESET
------	--	--------------------------------	--

(F1)		mm /in (F1) (F2) (F3) (F4)	Enter in St 1 mode Establish the probe constant Enter in ZZ mode Introduction of a PRESET
------	--	--	--

In ZZ mode, it is also possible to measure parallelism deviations (see chapter 4.13) and with a digital instrument the Perpendicularity deviations (see chapter 4.14)

### 4.12 PRESET function

The purpose of the PRESET function is to enter a value corresponding to the distance from the point of contact when reading the reference and the real reference. For example, when the base plate is the reference but it is not directly on that plate that you want to measure. In this case, you use a standard gauge block and enter its measurement as PRESET.

Thenceforth, probing the reference can be done on the shim itself.

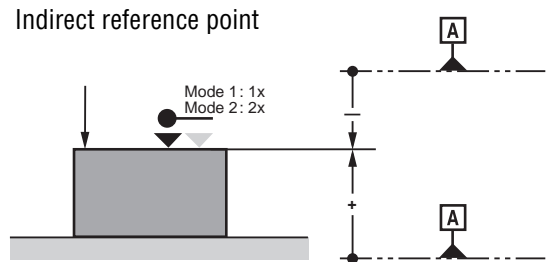

**« PRESET » function Mode 1 and 2**

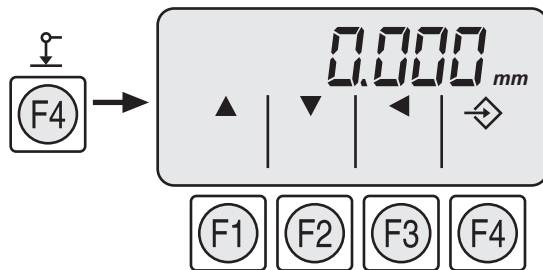











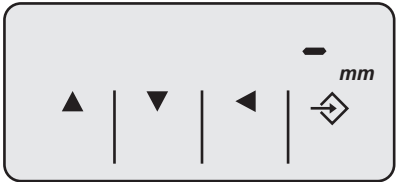



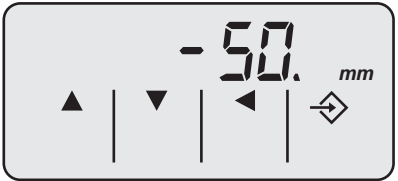

▲ Choice: 1 → 2 → 9 → . → 0  
 ▼ Choice: 0 → . → 9 → 2 → 1

- ◀ Shift one position to the left
- ⇒ Confirm preselected reading
- ⊗ Cancel preselected reading

**« PRESET » function : Sample entry -50.145 mm**

1

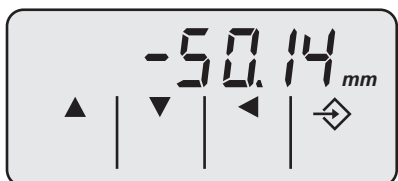

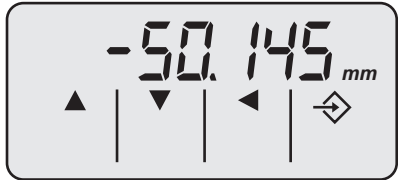
2	"-"	 2 x	
3	"5"	 1 x  5 x	
4	"0"	 1 x	
5	". "	 1 x  2 x	
6	"1"	 1 x  1 x	
7	"4"	 1 x  4 x	
8	"5"	 1 x  5 x	

9

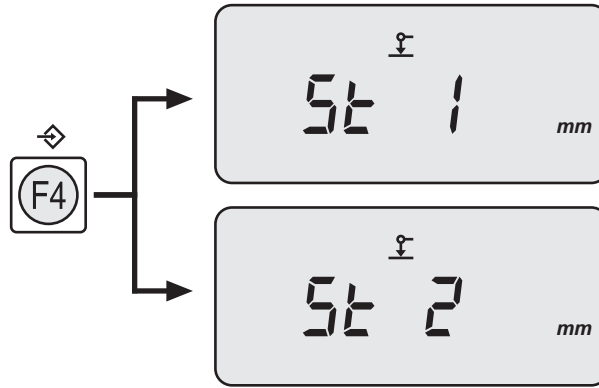

« PRESET » function : Cancellation

**IMPORTANT**

Each time a new reference is requested



the remains in memory

Deleting « PRESET »

Two possibilities:

A



B

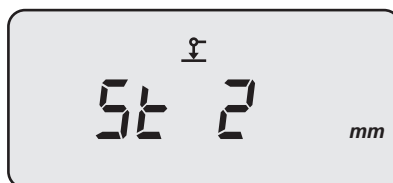
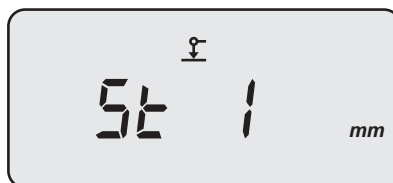
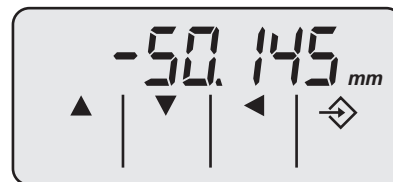

 « PRESET » function : Mode 3

Access and entry of « PRESET »  
As for Modes 1 and 2

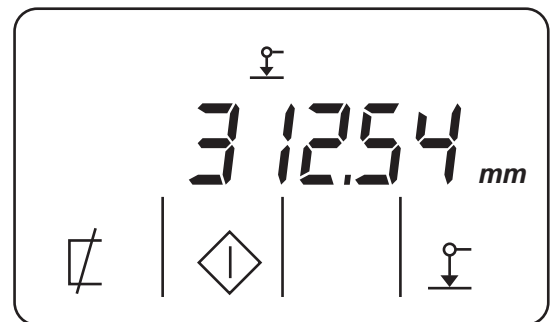
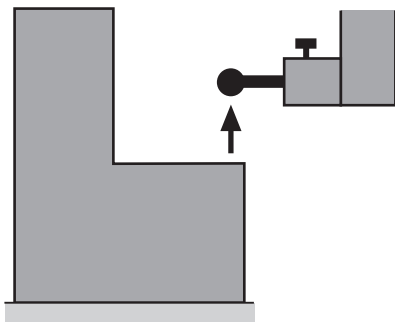
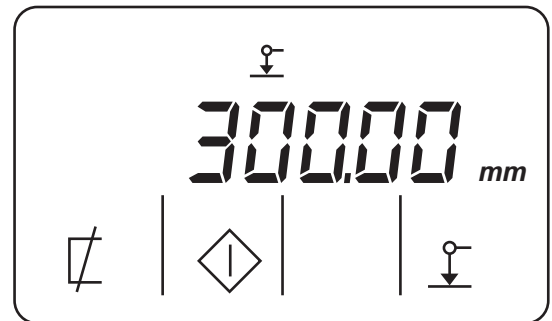
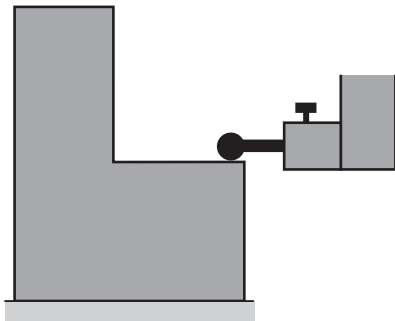
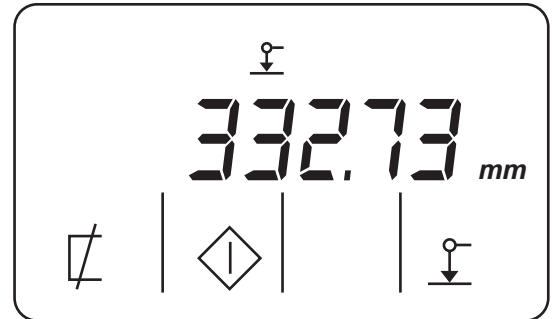
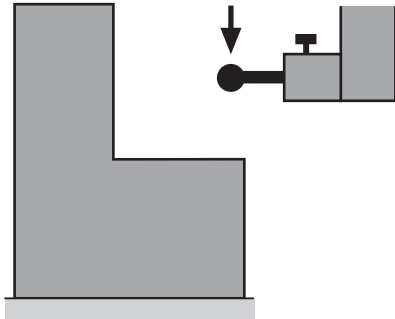



### 4.13 Measuring parallelism deviations

The measurement of the parallelism deviations is carried out in ZZ measuring mode. Place the gauge head in front of the surface to be controlled, do the probing and wait about 1 second in the probing zone. A bar graph appears and the measurement can be started by means of the F1 key and will be ended by means of the F4 key.

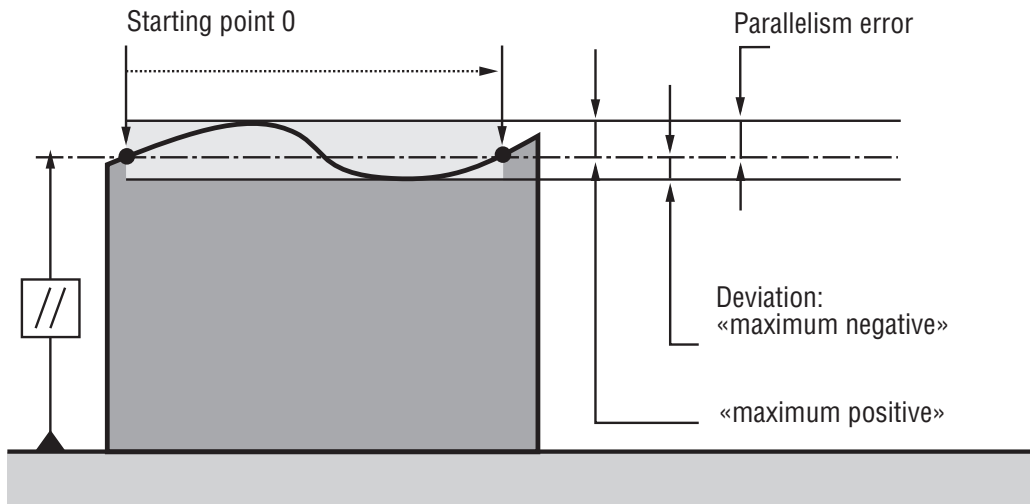

#### Detailed procedure of measuring parallelism deviations

Probe/Contact	Display	Active keys	Comments
		mm /in (F1) (F2) (F3) (F4)	Switch-on auto Print mode Establish the probe constant Enter in ZZ mode Introduction of a PRESET
(F3)		mm /in (F1) (F2) (F4)	<b>ZZ mode</b> <b>Continuous display</b> Return in St 1 mode Set the display to zero Introduction of a PRESET

Detailed procedure of measuring parallelism deviations

Probe/Contact	Display	Active keys	Comments
(F2)		mm /in (F1) (F2) (F4)	<p><b>Set the continuous display to zero</b></p> <p>Return in St 1 mode</p> <p>Set the display to zero</p> <p>Introduction of a PRESET</p>
Do a probing and wait 1 second in probing zone		(F1)	Start the measurement
(F1)		(F4)	<p><b>Capture the values</b></p> <p>Finish the measurement</p>
(F4)		(F3) (F4)	<p><b>Display of the result value MAX-MIN</b></p> <p>Return in ZZ mode continuous display ; allow to do a new measurement of parallelism deviations.</p> <p>Display the MAX value</p>

Detailed procedure of measuring parallelism deviations

Probe/Contact	Display	Active keys	Comments
F4		F3 F4	<p><b>Display of the result value MAX</b></p> <p>Return in ZZ mode continuous display ; allow to do a new measurement of parallelism deviations.</p> <p>Display the MIN value</p>
F4		F3 F4	<p><b>Display of the result value MIN</b></p> <p>Return in ZZ mode continuous display ; allow to do a new measurement of parallelism deviations.</p> <p>Display the MAX – MIN value</p>
F3		mm /in F1 F2 F4	<p><b>ZZ mode Continuous display</b></p> <p>Return in St 1 mode</p> <p>Set the display to zero</p> <p>Introduction of a PRESET</p>
F1		mm /in F1 F2 F3 F4	<p>Switch-on auto Print mode</p> <p>Establish the probe constant</p> <p>Enter in ZZ mode</p> <p>Introduction of a PRESET</p>

#### 4.14 Measuring perpendicularity deviations

Perpendicularity deviations and run-out errors are recorded using a lever indicator (e.g. TESATAST). This is fitted to the mounting pin (N° 00760222), which itself will be fixed to the probe-fixing arm of the TESA-Hite 400 / 700. When measuring perpendicularity, it is recommended that you clamp the measuring head.

**Clamping of the measuring head:** Move the measuring slide upward until the stop; exert a force on the handwheel, like if you would do a probing up; this will lock the transport carriage on the measuring carriage. To unlock the carriage do the same, but in the opposite direction. The measuring is effected by moving the measuring head vertically while observing the maximum and minimum deviations recorded by the lever indicator. When measuring run-out errors, it is also necessary to tighten the knurled screw locking the measuring-head drive 10.



It is also possible to measure the perpendicularity deviations using a digital instrument. To do it, fix the digital instrument on the probe fixing arm (N° 00760222) and connect the output on the interface (N° 04760070), itself connected on the RS connector of the TESA-Hite. It is recommended to use a GT21 inductive probe connected to a TT20. The bidirectional cable (N° 04761049) has to be used. The measuring time is 70ms that means 14 measurements per second. By using a DIOGICO 12 the measuring time will be 150ms that means 6 measurements per second.

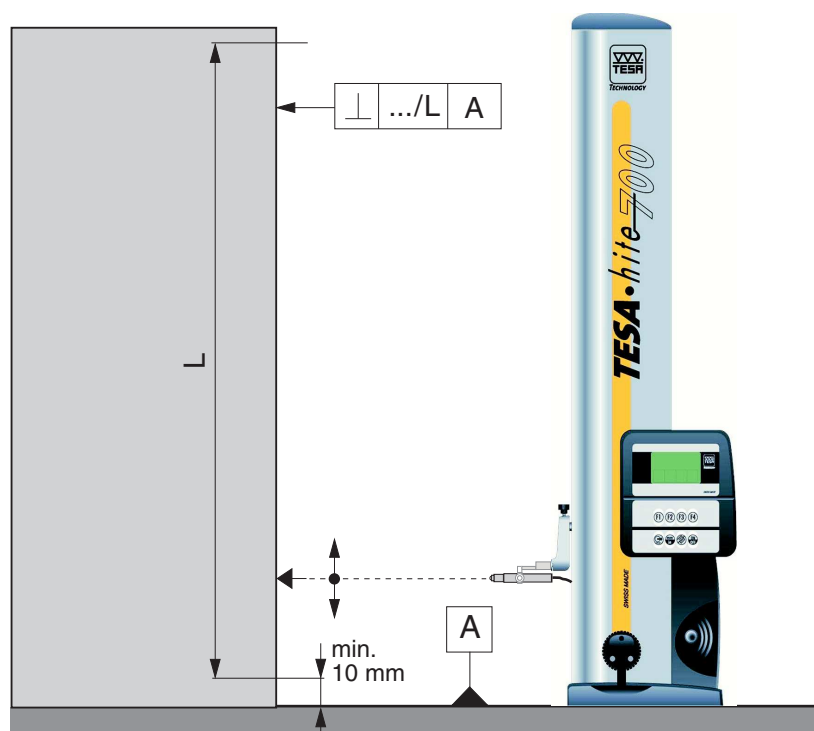

Detailed procedure of measuring perpendicularity deviations

Probe/Contact	Display	Active keys	Comments
		mm /in (F1) (F2) (F3) (F4)	Switch-on auto Print mode Establish the probe constant Enter in ZZ mode Introduction of a PRESET

Connect the digital instrument on the RS port of the TESA-Hite 400 / 700

(F3)		mm /in (F1) (F2) (F4)	<b>ZZ mode</b> <b>Continuous display</b> Return in St 1 mode Set the display to zero Start the perpendicularity measurement
(F2)		mm /in (F1) (F2) (F4)	<b>ZZ mode</b> <b>Continuous display</b> Return in St 1 mode Set the display to zero Start the perpendicularity measurement
(F4)		(F4)	<b>Capture the values</b> Continuous display of Z Finish the measurement

Detailed procedure of measuring perpendicularity deviations

Probe/Contact	Display	Active keys	Comments
		mm /in (F3) (F4)	<b>Display of the perpendicularity deviation.</b>  Return in ZZ mode continuous display ; allow to do a new measurement of perpendicularity deviation.  Display the angle of the regression line
(F4)		mm /in (F3) (F4)	<b>Display the angle of the regression line.</b>  Return in ZZ mode continuous display ; allow to do a new measurement of perpendicularity deviation.  Display of the perpendicularity deviation
(F3)		mm /in (F1) (F2) (F4)	<b>ZZ mode Continuous display</b>  Return in St 1 mode  Set the display to zero  Start the perpendicularity measurement
(F1)		mm /in (F1) (F2) (F3) (F4)	Switch-on auto Print mode  Establish the probe constant  Enter in ZZ mode  Introduction of a PRESET

#### 4.15 Use of the fine adjustment

The fine adjustment is used when one wants to precisely adjust a height in 3 «ZZ» mode. It can also be used when seeking the culmination point of a bore or a shaft. Indeed, in such a case, the probing force can be very finely adjusted affording great stability.

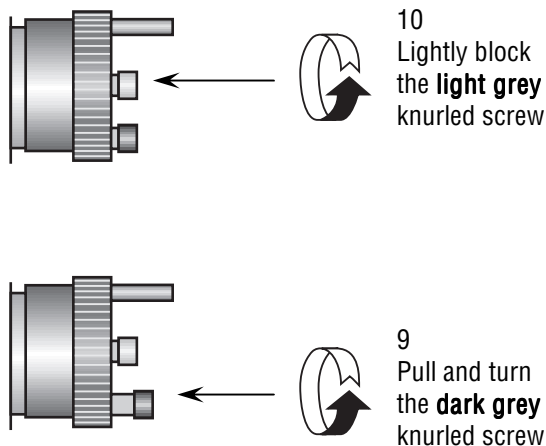

## 5 INSTRUMENT CONFIGURATION

To enter into the configuration mode, you have to activate by turned on the instrument, first the F1, then simultaneously the F1 and ON/OFF keys; after deactivate the ON/OFF and then the F1 key.

The configuration menu allows the following functions:

- F1: Activates or deactivates the Beep, when probing or detecting the culmination point.  
By default the Beep strong is active (BEEP Hi)
- F2: By default the TESA-Hite 400 / 700 turns off after 20 min (AUTO OF). To turn it off only with the ON/OFF button, set this option on ON.
- F3: Change the resolution of the instrument (0.0001 / 0.001 / 0.01 mm)  
By default the resolution is 0.0001 mm

Detailed procedure of the instrument configuration menu

Probe/Contact	Display	Active keys	Comments
<p>F1 and ON/OFF simultaneously</p>		<p>mm /in</p> <p>F1</p> <p>F2</p> <p>F3</p> <p>F4</p>	<p>Activates or deactivates the Beep</p> <p>Automatic turn off or not</p> <p>Change the resolution</p> <p>Exit of the configuration menu</p>
<p>F1</p>		<p>F1</p> <p>F4</p>	<p>Activates the Beep Lo</p> <p>Return to the configuration menu</p>
<p>F1</p>		<p>F1</p> <p>F4</p>	<p>Deactivates the Beep</p> <p>Return to the configuration menu</p>
<p>F1</p>		<p>F1</p> <p>F4</p>	<p>Activates the Beep Hi</p> <p>Return to the configuration menu</p>
<p>F4</p>		<p>mm /in</p> <p>F1</p> <p>F2</p> <p>F3</p> <p>F4</p>	<p>Activates or deactivates the Beep</p> <p>Automatic turn off or not</p> <p>Change the resolution</p> <p>Exit of the configuration menu</p>



Detailed procedure of the instrument configuration menu

Probe/Contact	Display	Active keys	Comments
F2		F2 F4	Turn off only with the ON/OFF button Return to the configuration menu
F2		F2 F4	Automatic turn off Return to the configuration menu
F4		F1 F2 F3 F4	mm /in Activates or deactivates the Beep Automatic turn off or not Change the resolution Exit of the configuration menu
F3		F3 F4	mm /in Change the resolution Exit of the configuration menu

Detailed procedure of the instrument configuration menu



Probe/Contact	Display	Active keys	Comments
F3		mm /in	F3 Change the resolution F4 Exit of the configuration menu
F3		mm /in	F3 Change the resolution F4 Exit of the configuration menu
F3		mm /in	F3 Change the resolution F4 Exit of the configuration menu
mm /in		mm /in	F3 Change the resolution F4 Exit of the configuration menu

Detailed procedure of the instrument configuration menu

Probe/Contact	Display	Active keys	Comments
		mm /in F3 F4	Change the resolution Exit of the configuration menu
F4		mm /in F1 F2 F3 F4	Activates or deactivates the Beep Automatic turn off or not Change the resolution Exit of the configuration menu
F4			

Then, to enter into the measuring mode, moves slowly the measuring carriage to pass the reference mark. For more detailed information, please consult chapter 2.2

## 6 ERROR MESSAGES

The error messages can be erased by pressing the key  or by turning off the instrument using the key .

- If **Error 4** displays, wipe the glass rule (see cleaning the glass rule in chapter 7.1).
- The message **Error 4** can also be caused by moving the measuring head to fast.
- The messages **Error 6** and **Error 9** indicate a fault in the electronic system.
- The acoustic message **Beep Error** detects a probe effected too brusquely.
- The message **Error 12** appears when a data transmission problem occurs between the digital instrument and the TESA-Hite 400 / 700 during the perpendicularity measurement.
- If an error message persists, send the instrument to your TESA after-sales service agent.

## 7 MAINTENANCE

### 7.1 Cleaning

The TESA-Hite 400 / 700 must be used in a place that complies with the extreme operating and storage conditions indicated in the technical data. If the instrument is not being used, we recommend that it be covered with the protective cover that is supplied as an optional extra.

To clean the TESA-Hite 400 / 700, use exclusively a dry, lint-free cloth. Do not use aggressive solvents.

#### Warning

The cleaning of the guides and the glass rule is a delicate operation; we consequently recommend that you proceed with the utmost caution.

#### Preparation

Remove the housing by unscrewing the 3 screws located on the top of the base.

#### Cleaning the guides

Clean the guide rails Fig. 4 with a lint-free cloth and relubricate the guide rails with watch oil.

#### Cleaning the glass rule

Clean the glass rule, Fig. 4, with a lint-free cloth, possibility slightly moistened with alcohol (do not use other solvents)

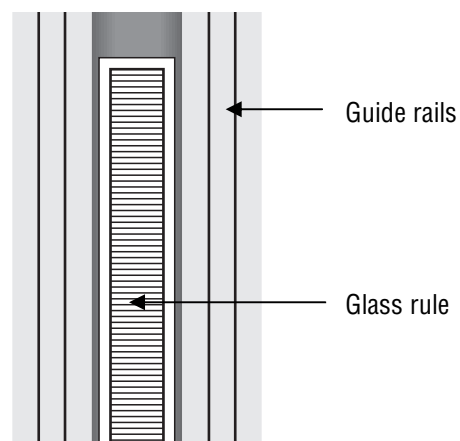

Fig. 4

## 7.2 Charging the battery

First of all, you should know that new batteries or batteries that are not used for a long period of time only attain their full performance after 30 to 40 charges.

Fully recharging the battery pack with the mains adaptor N° 04761054 requires about 8 hours. The TESA-Hite 400 / 700 M can then be used for about 60 hours. If the battery charge is not sufficient (under 5,8 V), the battery symbol appears on the display. The operator can continue with the measurements for about 15 minutes. Once this time has gone, the operating function will deteriorate.



For charging batteries, use only the original adaptor N° 04761054 and proceed as follows:

- Connect mains adaptor to the socket located on the back of the TESA-Hite 400 / 700.
- Connect adaptor to the mains 110 to 240 Vac / 50 to 60 Hz with connecting cable supplied.
- Complete charging takes about 8 hours.
- After full recharging, the adaptor may remain connected to the mains up to max. 24 hours without danger to the battery.
- During the recharging it is still possible to use the instrument; the time necessary for the recharge will simply be longer.

### Note

Unused batteries will gradually lose charge as time goes by and, if not recharged, deteriorate. They must therefore be charged at intervals which do not exceed 6 months.

## 8 DELIVERY PROGRAMME

The order numbers are the following:

TESA-Hite 400	00730043
TESA-Hite 700	00730044

Each TESA-Hite is supplied with the following standard accessories:

- 1 Standard insert holder	00760143
- 1 Standard hard metal measuring insert with a 5 mm t.c. ball tip	00760227
- 1 Master piece with nominal dimension 6.350 mm / 0.2500 in	00760219
- 1 Electric pump for creating the air-cushion	00760142
- 1 Rechargeable 6V battery	00760157
- 1 Mains adaptor 110 to 240 Vac / 50 to 60 Hz	04761054
- 1 Cable EU	04761055
- 1 Cable US	04761056
- 1 SCS calibration certificate	
- 1 Instruction manual with a declaration de conformity	
- 1 Shipping box	

00760219

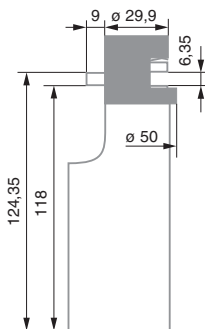

00760227

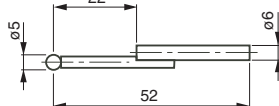

00760143

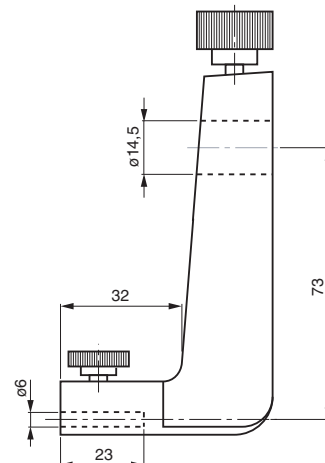

### 8.1 Optional accessories

All insert holder and measuring insert from MICRO-HITE can be used with the TESA-Hite 400 / 700.

#### Measuring insert

With tungsten carbide ball tip,  $\varnothing$  10 mm.

N° 00760060\*

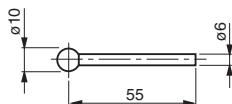

#### Measuring insert

With tungsten carbide ball tip,  $\varnothing$  3 mm.

N° 00760061\*

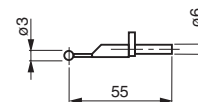

#### Measuring insert

With tungsten carbide measuring face (convex), for inspecting cylindrical bores or establishing internal thread position (metric or similar).

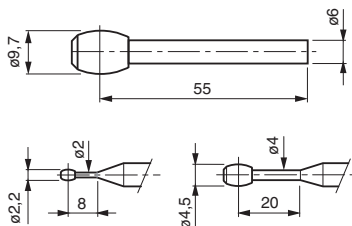

D = 2,2 mm for M3 to M16      N° 00760066  
 D = 4,5 mm for M6 to M48      N° 00760067  
 D = 9,7 mm for M12 to M150      N° 00760068

#### Measuring insert

With disc-shaped, tungsten carbide measuring face for measuring grooves, turned grooves, centring shoulders, etc.

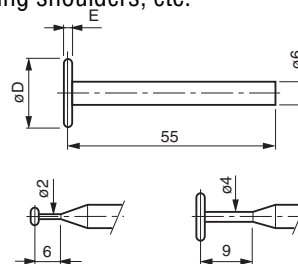

E = 1 mm /  $\varnothing$  4,5 mm      N° 00760074  
 E = 2 mm /  $\varnothing$  14 mm      N° 00760075\*  
 E = 3 mm /  $\varnothing$  19 mm      N° 00760076

#### Measuring insert

With small tungsten carbide measuring face,  $\varnothing$  2 mm,

N° 00760082

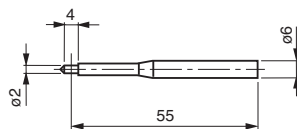

#### Indexing of the insert holder

To screw on the mounting pin

N° 00760225

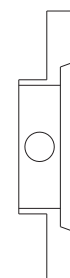

**Insert holder**

For measuring inserts with M1,4 threads (see opposite) and M2,5 threads.

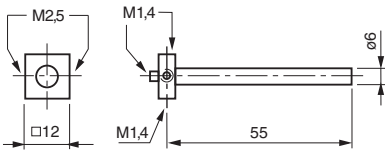

N° 00760096\*

**Measuring insert**

With tungsten carbide ball tip with M1,4 thread.

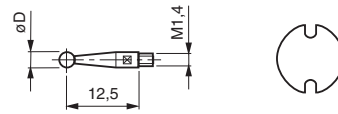

Ø 1 mm      N° 01860201\*  
 Ø 2 mm      N° 01860202\*  
 Ø 3 mm      N° 01860203\*  
 Key          N° 01860307\*

**Measuring insert**

With a Ø 10 mm tungsten carbide cylindrical face and 12 mm length. Hardened stainless steel body.

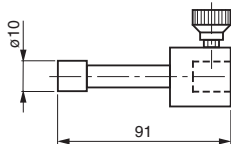

N° 00760093\*

**Measuring insert**

With both a flat and spherical tungsten carbide measuring face. Hardened stainless steel pin, interchangeable.

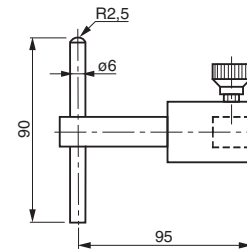

N° 00760094\*

**Insert holder**

For increasing the measuring depth.

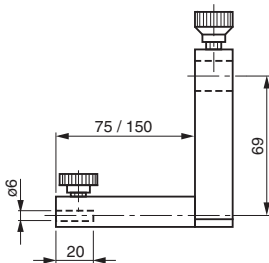

Depth 110 mm (L = 75 mm)      N° 00760086  
 185 mm (L = 150 mm)      N° 00760087

**Insert holder**

For extending the application range.

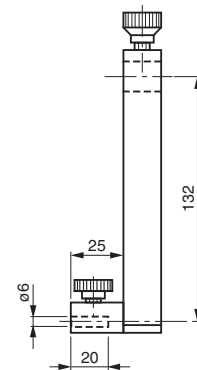

N° 00760057

**Partial set of accessories      N° 00760173**

With those of the above accessories marked by an asterisk «\*». Supplied in a polypropylene case (not shown on these pages).

**Full set of accessories      N° 00760148**

With all above accessories. Supplied in a polypropylene case (not shown on these pages).

**Measuring insert**

With hardmetal shaft and tungsten carbide ball tip :

- Ø 1 mm      N° 00760228

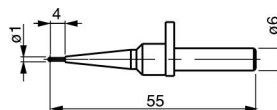

- Ø 2 mm      N° 00760229

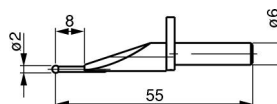

- Ø 3 mm N° 00760230

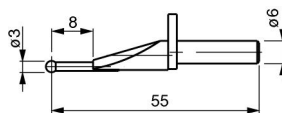

Holder for GT probes or dial test indicator  
N° 00760222

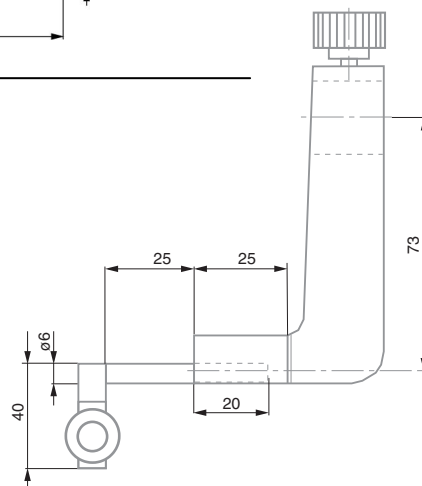

Probe insert set  
N° 00760175

Supplied in a suited plastic case.

Composition of the set:

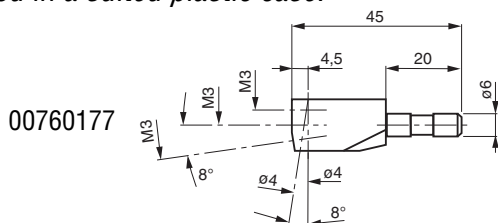

1 Insert holder N° 00760177

1 Probing pin  
In hardened steel for grooves, centring shoulders, blind bores, etc. Tilted through 8° N° 00760178

1 Probing pin  
In hardened steel, shouldered, for depth measurement N° 00760179

3 Measuring inserts  
With a hardened ball tip, Ø 0.9 mm N° 00760180  
Ø 1.9 mm N° 00760181  
Ø 2.9 mm N° 00760182

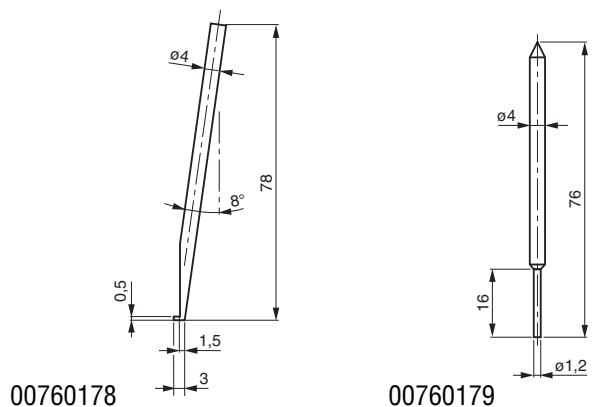

1 Measuring insert  
With a Ø 8 mm cone-shaped measuring face in hardened steel N° 00760183

2 Extensions  
Length 20 mm, thread M3 to M3 N° 00760184  
Length 20 mm, thread M3 to M2,5 N° 00760185

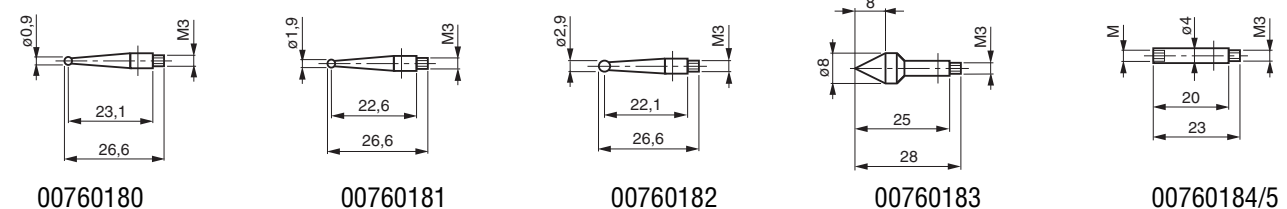

TESA PRINTER SPC  
N° 06430000

Supplied with:

1 Roll heat sensitive paper N° 04765013  
1 Mains adaptor, 100 to 240 Vac / 50 to 60 Hz, 6,6 Vdc / 750 mA N° 04761054  
1 Cable EU N° 04761055  
1 Instruction manual with declaration of conformity

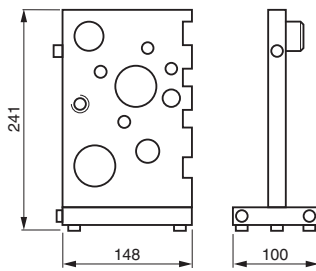

**OPTIONAL ACCESSORIES**

**Connection cable**

- RS232 9 p m/f, length 2 m
- RS-USB 9p m/USB, length 2 m

**N° 04761052**
**N° 04761063**
**Practice workpiece**
**N° 00760124**
**9 TECHNICAL DATA**
**CHARACTERISTICS**

	<b>TESA-Hite 400</b>	<b>TESA-Hite 700</b>
Measuring span	415 mm / 16 in	715 mm / 28 in
Application range		
with standard insert holder 00760143	570 mm / 22 in	870 mm / 34 in
with insert holder 00760057	625 mm / 24 in	925 mm / 36 in
with insert holder S07001622	795 mm / 31 in	1095 mm / 43 in
Maximum permissible error*	(2.5+4 L)µm (L in m) / (0.0001+0.000004 L)in L in inch	
Repeatability*	on flat surface: 2s=<2µm / 2s=< 0.0001in within bores: 2s=<3µm / 2s=< 0.00015in	
Maximum perpendicularity error (frontal)	9µm / 0.00035in	13µm / 0.0005in
Display	liquid crystal display (LCD)	
Display size	83 x 49 mm	
Resolution	0.0001/0.001/0.01 mm – .00001/.0001/.001 in	
Number of decades	7 plus minus sign	
Character size	12 mm	
Additional display	symbols for the functions	
Instrument base	grey cast iron with rectified sole incorporating 3 support lugs	
Guidance across the reference surface	through mechanical contact	
Material measure	incremental glass scale with reference point	
Capturing	opto-electronic	
Coefficient of linear expansion	12±1.5 10 <sup>-6</sup> K <sup>-1</sup>	
<b>Measuring head</b>		
Guiding	on ball-bearings	
Head displacement	with a handwheel	
Maximum perm. displacement speed	1 m/s	
Value capture	automatic	
Force exerted by measuring head	1.5N ±0.5N (acoustic signal)	
when taking readings	8 keys for selecting the functions and entering the values	
Keypad	yes	
Air cushion	yes	
Power supply	6V rechargeable battery	
Autonomy	60 hours, recharging time 8 hours	
Data output	RS-232	
Measuring head lock	yes	
Fine adjustment	yes	
Operating temperature range	10°C to 40°C	
Storage temperature range	-10°C to 60°C	
Maximum relative humidity	80%	
Weight	27 kg	32 kg
Degree of protection	IP40 (Electronic box IP65)	
Electromagnetic compatibility	EN 50081-1, EN 50081-2	
With mains adaptor disconnected	EN 50082-1, EN 50082-2	
Marked with individual identification number		
* Valid with standard accessories		

## 9.1 Description of the RS 232 interface

To link the TESA-Hite 400 / 700 to a Printer SPC or a PC, use the cable 04761052.

Transmission speed	4800 bauds
Character length	7 bits
Start	1 bit
Stop	2 bits
Parity	even

### 9.1.1 Monodirectional data transmission

The data transfer is done by activating the function key



#### Transfer

mm            ±9999.999(9) <cr/lf>  
 In             ±99.99999 <cr/lf>

### 9.1.2 Bidirectional data transmission

This transmission mode allows direct control of the height gauge from a PC. Given instructions are as follows:

Each command must be ended using ASCII code «CR»

<b>?&lt;cr&gt;</b>	Measured value	
<b>ID ?&lt;cr&gt;</b>	Product identification number	<b>TE...&lt;cr/lf&gt;</b>
<b>VER ?&lt;cr&gt;</b>	Instrument version	<b>2.1&lt;cr/lf&gt;</b>
<b>UNI ?&lt;cr&gt;</b>	Unit system	<b>MM ou IN&lt;cr/lf&gt;</b>
<b>MM&lt;cr&gt;</b>	Work in metric (mm)	<b>&lt;cr/lf&gt;</b>
<b>IN&lt;cr&gt;</b>	Work in inch (in)	<b>&lt;cr/lf&gt;</b>

The pin assignment on the 9 pin (female) connector is as follow:

<b>Control panel</b>		<b>PC</b>
2 TXD (Data Out)	→	2 RXD
3 RXD (Data Req)	←	3 TXD
5 GND		
Other pins are leaved unused		

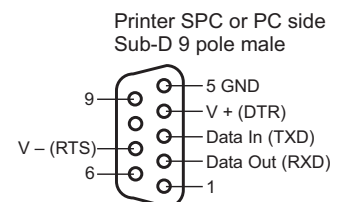

## 10 WARRANTY

We guarantee this product against any fault of design, manufacture or material for a period of 12 months from the date of purchase. Any repair work carried out under the guarantee conditions is free of charge. Our responsibility is limited to the repair of the product or, if we consider it necessary, to its free replacement.

The following are not covered by our guarantee: batteries and damages due to incorrect handling, failure to observe the instruction manual, or attempts by any non-qualified party to repair the product; any consequences whatever which may be connected either directly or indirectly with the product supplied or its use.

*(Extract from our General Terms of Delivery, December 1, 1981).*

## 11 DECLARATION OF CONFORMITY

We thank you very much for your confidence in purchasing this product. We hereby certify that it was inspected in our works.

### Declaration of conformity and confirmation of traceability of the indicated values

We declare under our sole responsibility that this product is in conformity with all technical data as specified in our sales literature (instruction manual, leaflet, general catalogue). In addition, we certify that the measuring equipment used to check this product refers to national reference standards. Traceability of the measured values is ensured by our Quality Assurance.

#### Name of manufacturer

TESA SA

#### Address of manufacturer

TESA SA  
Rue du Bugnon 38  
CH-1020 Renens  
(Switzerland)

#### We declare that the following product(s)

Name of product      TESA-Hite 400 / 700  
Type of product      00730043 / 00730044  
is (are) in conformity with the provisions of the European directive  
2004/108/CE

And is (are) in conformity with the provisions of the European Standards  
EN 61326-1

Renens, the 22.02.2010

Manager of Quality Assurance.

